

# CONNECTORS MANUFACTURE



## Female Header 2.0mm 1 Row H=4.3mm Right Angle Type

### Specifications

Current Rate: 2.0 AMP  
 Insulation Resistance: 1000MΩ Min.  
 Contact Resistance: 20mΩ Max.  
 Dielectric Voltage: 500V AC for one minute  
 Operation Temperature: -40°C to +105°C

### Material

Insulator: Polyester, UL 94V-0  
 ©Standard: PBT or Nylon 6T  
 Terminal: Copper Alloy  
 Plating: Gold Plated

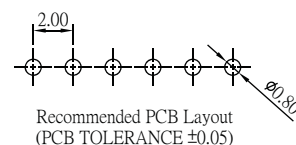
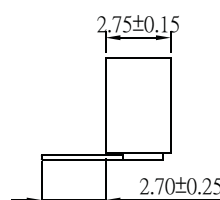
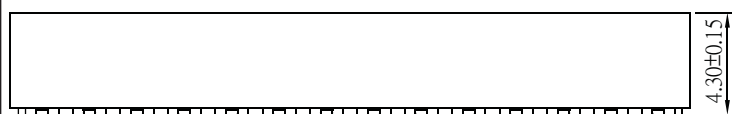
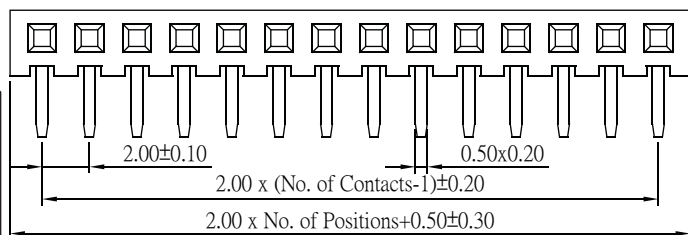
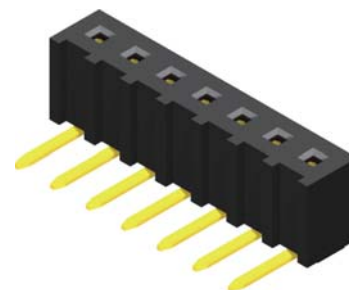

Part No.: PS2R43-1XX-L/U

F emale Header 2.0mm

## Female Header 2.0mm 2 Row H=4.85mm Right Angle Type

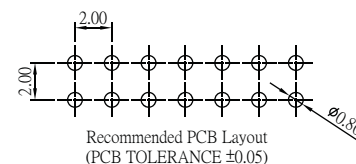
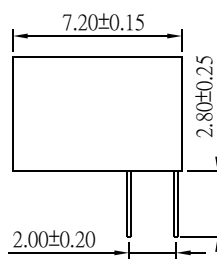
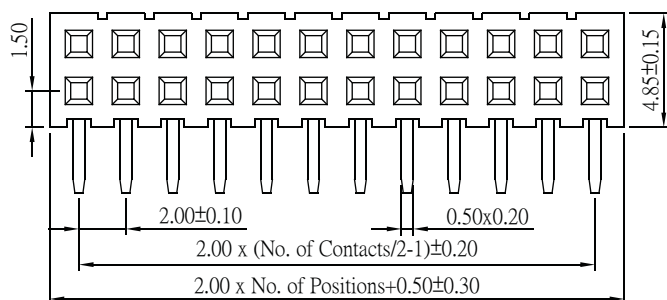
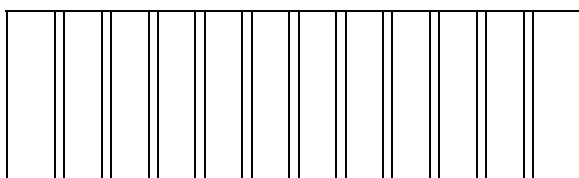

Part No.: PS2R49-2XX-L/U

## ORDER INFORMATION

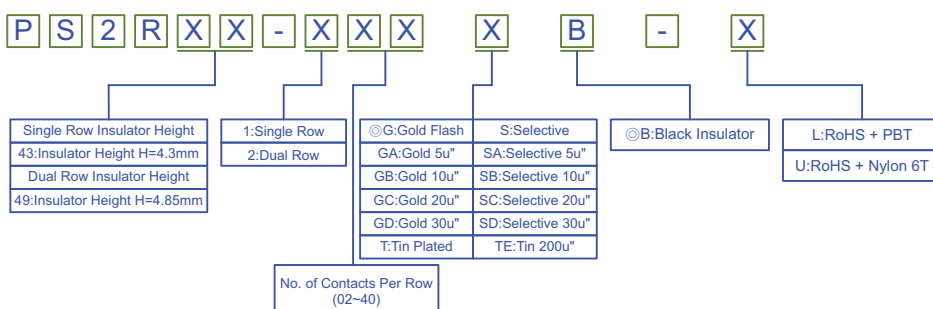

©Standard Recommended

CONNECTORS MANUFACTURE



ROHS